

HANOVER® PREST® PAVER

Nominal 12" x 36"

11 3/4" x 35 3/8" x 2"

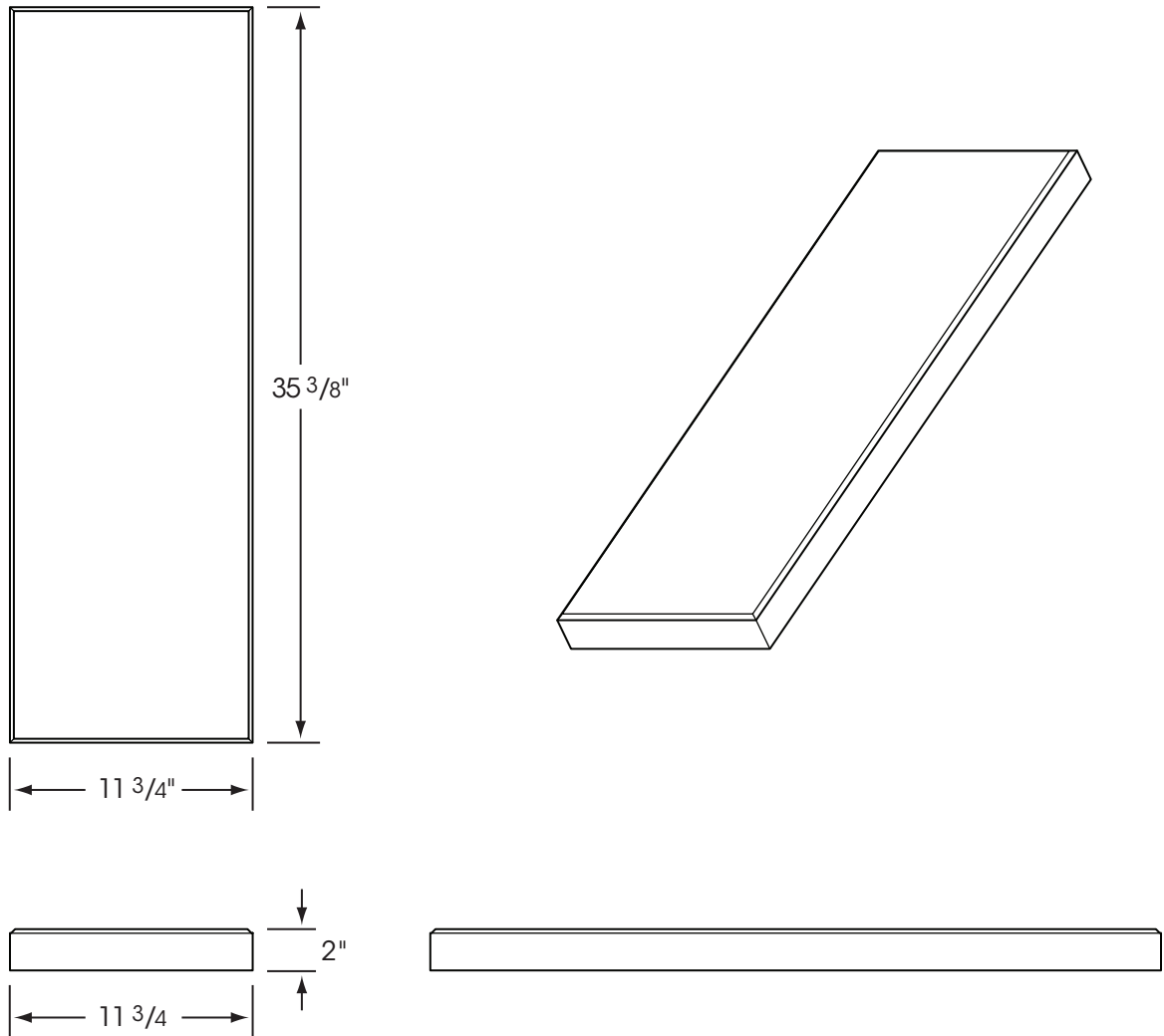

Thicknesses ranging from 1 1/2" - 3" are also available. A variety of dimensionally compatible sizes are available for installation with the 12" x 36" Paver. Contact Hanover® for a list of sizes.

Pavers are manufactured with a standard 3/16" bevel. A square edge option is also available upon request.

Please Note: Sizes shown are nominal. Products are made to fit metric modules.
Pavers should be laid maintaining a minimum 1/8" joint.

HANOVER®
Architectural Products
5000 Hanover Road, Hanover, PA 17331
717.637.0500 fax 717.637.7145
www.hanoverpavers.com