

PERMEABLE PAVING UNIT

Permeable 3 1/4" x 18"

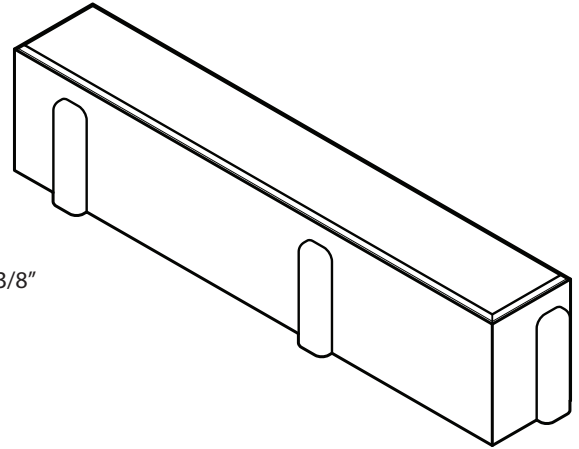

3 1/4" x 18" x 4"

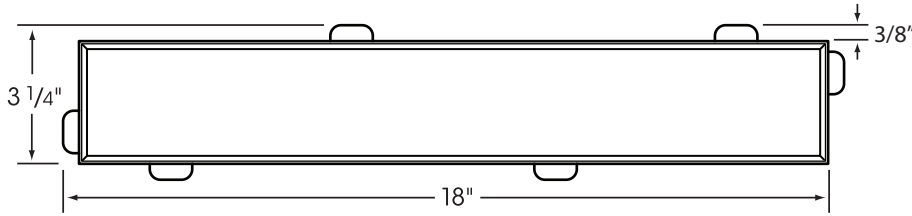

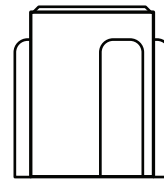
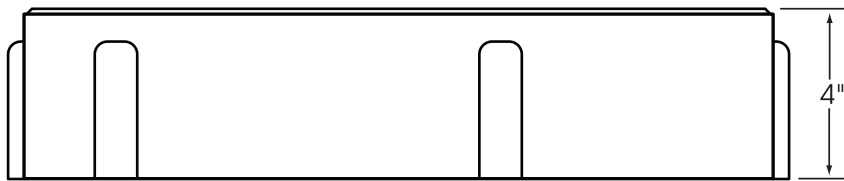
10% OPEN AREA PER UNIT



PEDESTRIAN VS. VEHICULAR USAGE COMPARISON

	HANOVER® PRODUCT	 PEDESTRIAN USE	 LIGHT VEHICULAR USE	 MODERATE VEHICULAR USE
		use by persons on foot and any mobility impaired persons using a wheelchair	pedestrian use & low speed, low volume residential and light commercial vehicular use	pedestrian use & low speed, moderate volume residential and moderate commercial vehicular use
		MINIMUM THICKNESS	MINIMUM THICKNESS	MINIMUM THICKNESS
PERMEABLE PAVING UNITS	Aqua-Loc®	3"	3"	3"
	EcoGrid®	4"	4"	NO MODERATE VEHICULAR USE
	Permeable 4" x 8"	3"	3"	3"
	Permeable 4 1/2" x 9"	3"	3"	3"
	Permeable 4 1/2" x 9" Scored	3"	3"	3"
	PERMEABLE 3 1/4" X 18"	4"	NO LIGHT VEHICULAR USE	NO MODERATE VEHICULAR USE
Permeable 12" x 18"	3"	NO LIGHT VEHICULAR USE	NO MODERATE VEHICULAR USE	

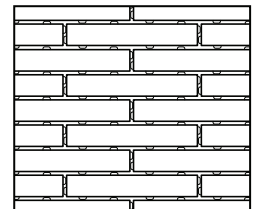

Running Bond

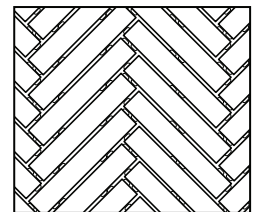

45° Herringbone

Please Note: Sizes shown are nominal. Products are made to fit metric modules. Overall dimensions include one spacer.

HANOVER®
Architectural Products
 5000 Hanover Road, Hanover, PA 17331
 717.637.0500 fax 717.637.7145
 www.hanoverpavers.com